

WINDGATE SH

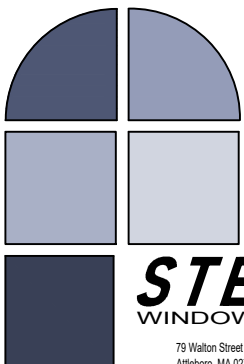
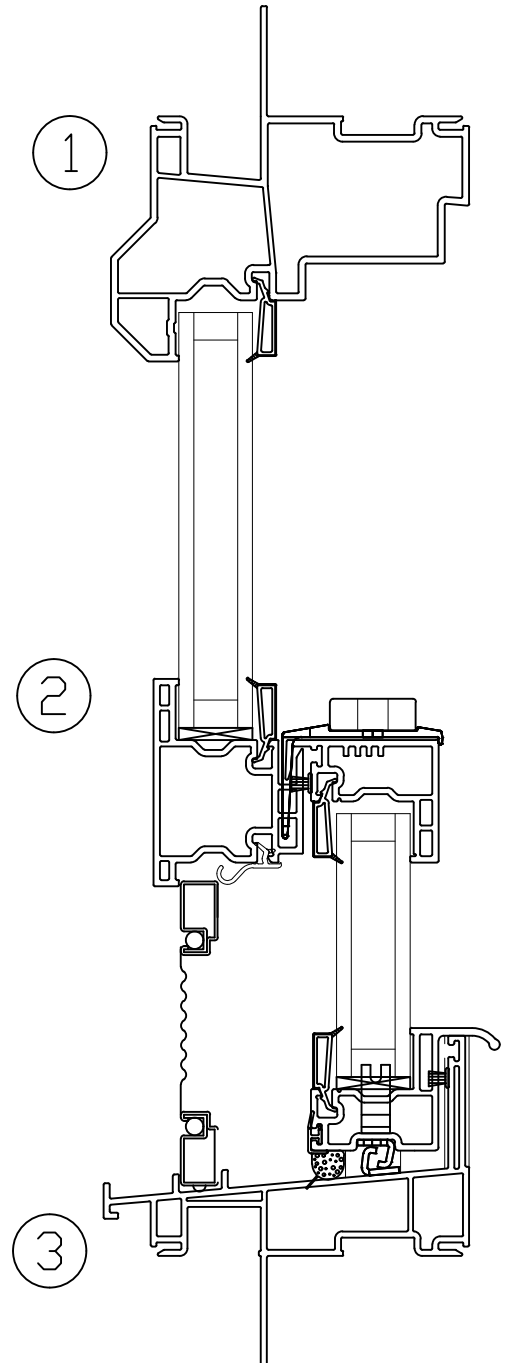
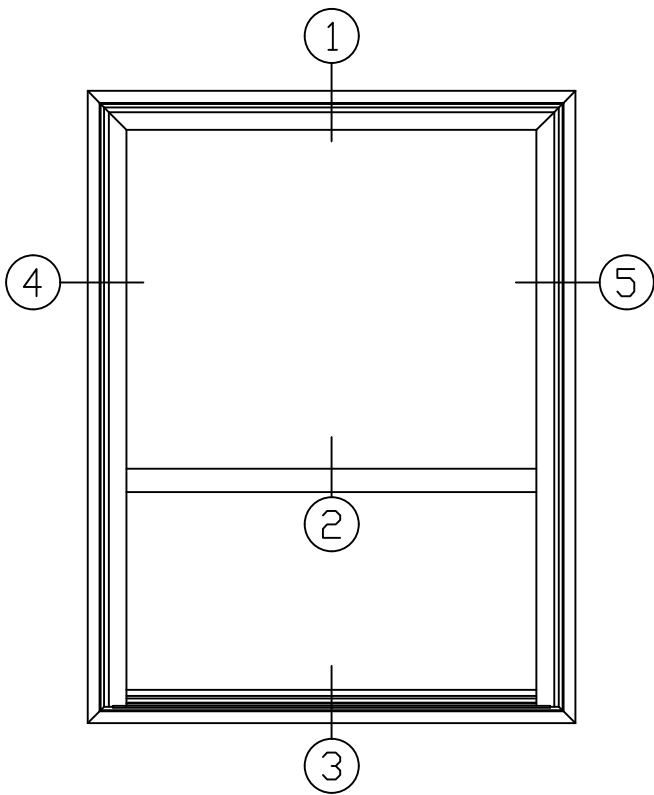
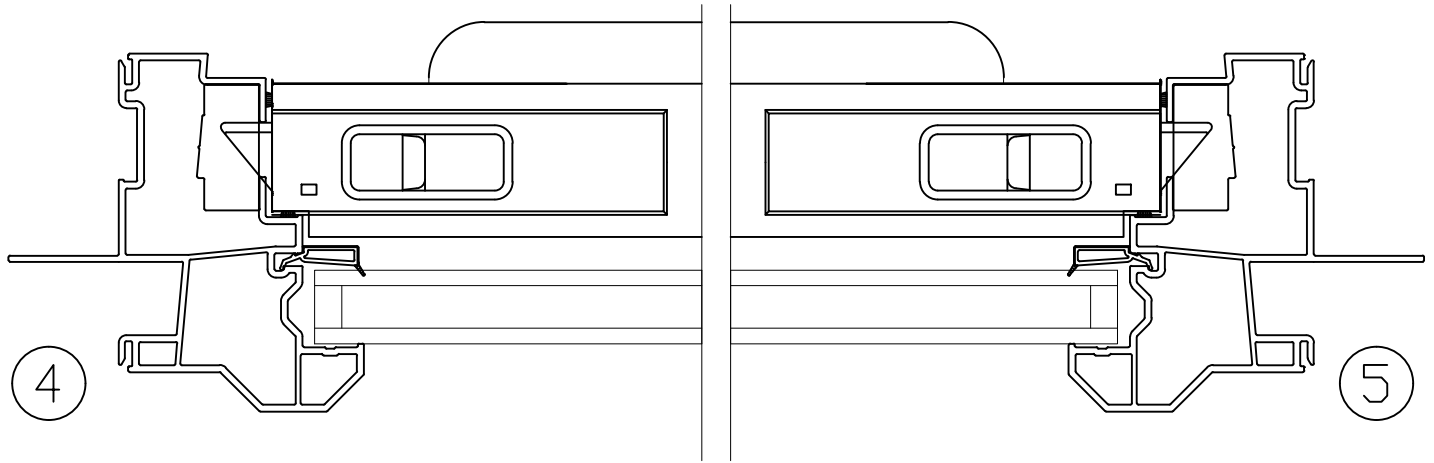

STERGIS
WINDOWS & DOORS

79 Walton Street PH: 508.455.0661 Toll Free 1.888.STERGIS
Attleboro, MA 02703 FX: 508.455.0622

WINDGATE 6051